

OERLIKON

G 30

BEVEL GEAR TECHNOLOGY – GRINDING MACHINES



KLINGELBERG

A LEADER IN BEVEL GEAR TECHNOLOGY

Intelligent Solutions for Discerning Users

Around the world, manufacturers of gears and gearboxes ensure their leading edge in gear machining with innovative solution concepts from Klingelberg.

The [Oerlikon Bevel Gear Technology](#) division does not just allow users to manufacture bevel gears economically and with high precision. All machines in the system have been designed to work together to enable pre-machining and finishing of even the most complex gears.

Klingelberg offers the most advanced technology and the most efficient machines for each and every step in the process chain. The production process chain for bevel gears includes [tool preparation](#), [cutting](#), [measuring](#), hardening, [grinding](#) or [lapping](#) and [testing](#), among others. The powerful [KIMoS \(Klingelberg Integrated Manufacturing of Spiral Bevel Gears\)](#) design software and the [Closed Loop concept](#) ensure transparency and documented quality throughout the entire process chain.

Oerlikon bevel gear machines are developed with real-world applications in mind and meet the varying demands of a whole range of industries. The target markets include the automotive industry, commercial vehicle industry, agricultural industry, shipbuilding and aviation, as well as industrial gearbox manufacturing and industrial engineering.

As a leading system supplier and in combination with these high-performance tool systems, Klingelberg meets every requirement for flexible, efficient production — for the smallest and the largest batch sizes.



Oerlikon bevel gear grinding machine G 30 with numerous equipment details

For Every Process Step in Gear Technology,
Klingelberg Provides Exceptional Concepts

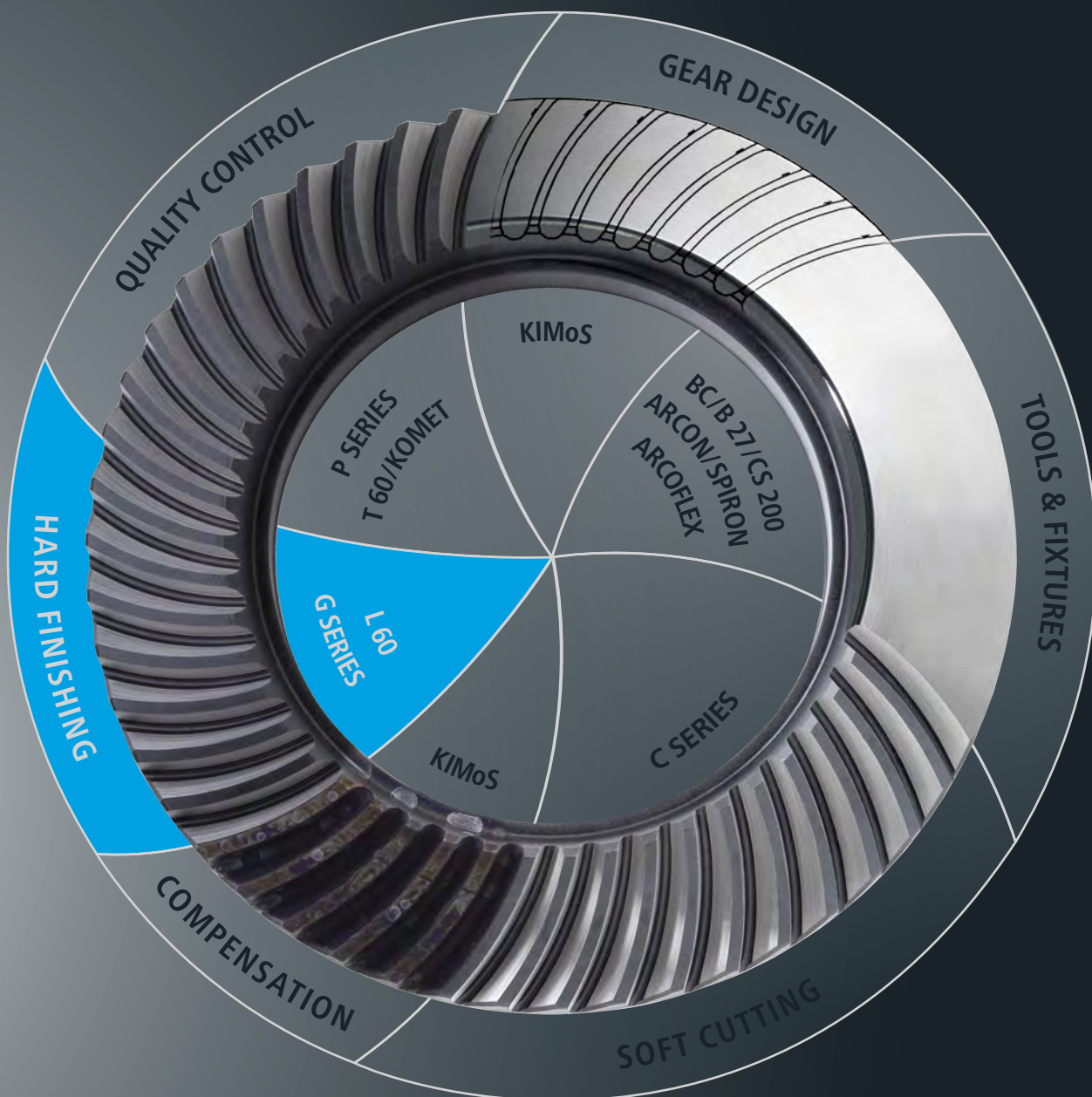

Leading-Edge Technology for Optimal Flexibility and Maximum Productivity

Thanks to ongoing advancement of the vertical concept, the Oerlikon bevel gear grinding machine G 30 sets new standards in grinding.

All bevel gear machines in this series are equipped with a thermostable, vibration-damping machine bed. The grinding machine utilizes an optimized axis arrangement, resulting in reduced approach paths that ensure a significantly reduced load on the drive components and at the same time a stiffer design of the complete system. The G 30 can be optionally equipped with a side loader, allowing for easy loading in automatic mode using a machine-integrated loading shuttle or handling robot. For series production, the machine also offers a range of process monitoring functions.

A key highlight of this machine series is its innovative operating concept and ultra-modern control technology. The modern touchscreen display and the newly developed operating concept make the G 30 more intuitive to operate compared with standards commonly found on the market. (See page 9 for more on the operating concept).

For Klingelnberg, it is also extremely important for all machine tools to be service- and maintenance-friendly. The advanced machine design makes maintenance work easier, significantly reduces the need to procure spare parts, and achieves maximum energy efficiency.

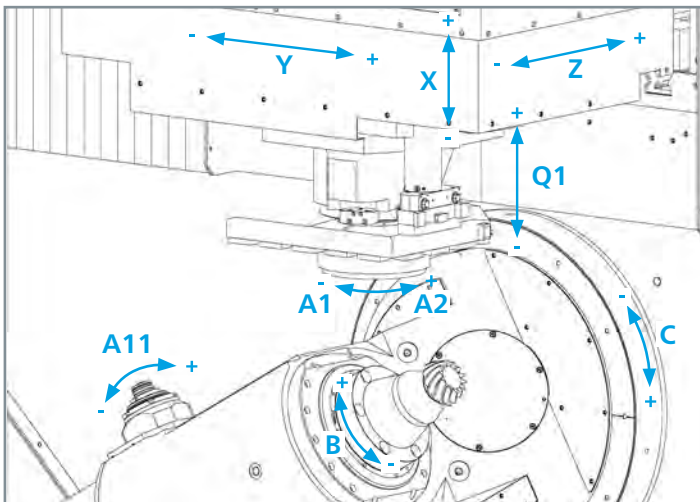

Axis arrangement of an Oerlikon bevel gear grinding machine G 30

- Ongoing advancement of the vertical concept to eliminate grinding swarf deposits in the working chamber
- Extremely rigid, heat-stable machine for optimal machining results, even for highly productive processes
- Side loading with machine-integrated shuttle or handling robot (optional)
- Modern operating software with touchscreen display and user-defined screen configuration
- Optimal energy efficiency thanks to recovery and on-demand powering of units

CNC axes:

A1 grinding spindle
 A2 eccentric spindle
 B work spindle
 C base angle setting

Q1 coolant adjustment axis
 A11 dressing spindle
 X, Y, Z linear axis

An All-In-One Solution: Single-Part Production and Mass Production Applications in One Machine

Deep Grinding

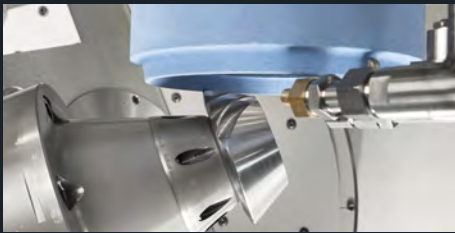

- Soft-stage gear grinding of bevel gears for prototype and small-batch production

Finish Grinding



- Hard finishing of bevel gears to the highest standards of quality and productivity

Dressing



- Custom grinding wheel profiling and conditioning
- Highly efficient tool pre-profiling in the machine

HIGHLIGHTS

Unrivalled Cycle Time — Ring Gear Finishing

As demonstrated by the example of a 45-tooth ring gear for a passenger car, the potential of the G 30 is evident:

Processing steps:

- Gap finding with stock divider probe , three gaps in 14 sec
- Grind gear in 76 seconds
- Dress grinding wheel, spin off, unload and load component with machine-integrated loader in 22 seconds
- Optionally, pitch can be measured and index error compensated on the first component

Result:

In just **112 seconds** the component can be ground, oil spun off and changed out.

High-Tech can be so Easy!

“Simplified with Passion” - true to this motto, Klingelberg is driven to provide simple solutions to high-tech challenges. A team of engineers and technical experts makes it possible — always with the goal of ensuring the highest technological standards in application-matched machine concepts that are also easy to use.

Case in point: the G 30 grinding machine is based on established development concepts that are continually being advanced. Klingelberg’s success factors include:

- high productivity with the lowest possible per-piece costs and maximum process safety
- unique Closed Loop concept for the entire bevel gear machining process chain
- comprehensive service offering with a broad service network
- outstanding technical expertise and expert knowledge, which Klingelberg passes on to customers in professional seminars



Oerlikon bevel gear grinding machine G 30 for workpiece diameters up to 300 mm



Vertical Machine Concept for Secure Process Sequences

- Vertical grinding spindle for optimal swarf removal
- Excellent visual process monitoring during process set-up , thanks to optimal machining position of vertical grinding spindle
- Component and clamping device “gravity assisted” in vertical direction
- Smooth surfaces and minimal interference contours in the working chamber combined with efficient interior cleaning to eliminate grinding swarf deposits (optional)

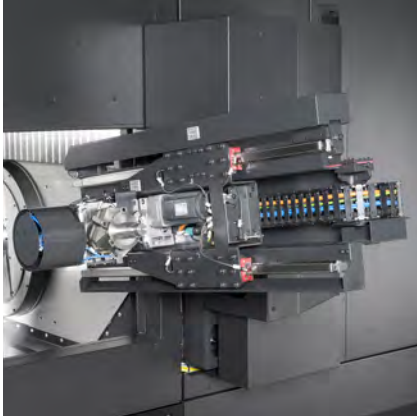

Suitable for Batch Production Thanks to High-Speed Workpiece Change-Out (Optional)

- Optimal workpiece change, since loading system is fully integrated into the machine
- Highly dynamic drives for minimal downtimes
- Integrated NC axes mean intelligent coordination of machining process and workpiece changes
- Standardized Profibus interface for easy integration with external automation
- Minimal oil mist discharge thanks to smallest possible load opening
- Reduced oil loss with loading shuttle compared with robot

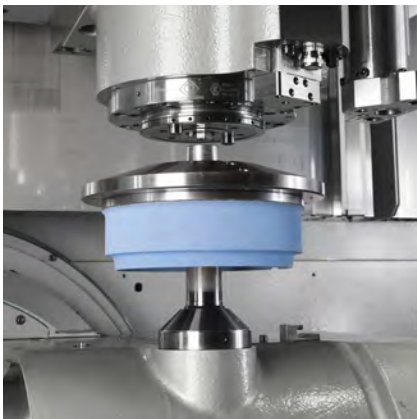

Minimal Retooling and Configuration Times

- Semi-automatic grinding wheel change with quick change adapter for quick change over
- Quick change of preset oil rings for grinding oil supply
- Full accessibility of working chamber through front service door, also for automatic loading
- Machine-integrated loading system with parallel-mounted gripper jaws for gear and pinion (optional)
- Efficient grinding wheel pre-profiling with special dressing software



Maximum Process Stability for High Volume Production due to Constant Process Monitoring

- Automatic contact detection for dressing with AE sensor (optional) enables minimal dressing amount without risk of profile loss
- Blank seating control to ensure proper workpiece seating for automatic loading (optional)
- Stock allowance check to detect parts not properly sized
- Grinding power monitoring with automatic spindle retract in case of power overload

HIGHLIGHTS



Machine-Integrated Set-Up and Quality Assurance (Optional)

- Quick process control with on-board measurement during production
- Highly precise measurement and excellent repeatability
- Easy calculation of correction values means no rejects in the bevel gear grinding process
- Automated calculation of corrections in the machine
- High indexing accuracy requires no in-depth user expertise



"Single-Piece" Grinding Oil Supply

- Optimal set-up reproducibility by means of quick change single piece oil supply ring for process cooling and cleaning
- Innovative, high-pressure-resistant telescope system for quick and easy adjustment of the grinding oil supply with minimal tool requirements for shorter set-up times
- Fully sealed system for maximum process cooling efficiency
- Consistent machining conditions thanks to automatic adjustment over the grinding wheel service life



Energy Efficiency (e²) for the Most Stringent Demands

- Energy-saving cooling technology thanks to effective control of the cooling units
- High energy-efficiency-class drives
- Intelligent reactive current compensation
- Efficient energy recovery

Intuitive Operating Concept with Trend-Setting Touch Technology

1 Multilingual menu navigation allows for worldwide use

2 Menu navigation is easy and requires minimal training thanks to innovative workflow support

3 Input errors are avoided by the intelligent warning function preventing costly incidents or even accidents

4 Machine configuration is successfully completed in just a few steps



5 High production reliability ensured by visualization of the production workflow in real time (dashboard)

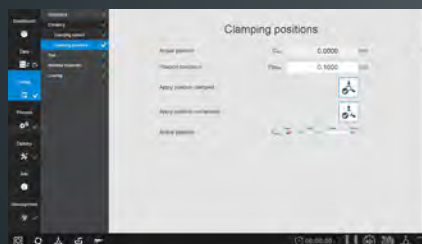

6 Fast, easy control of all program functions in a single graphical user interface

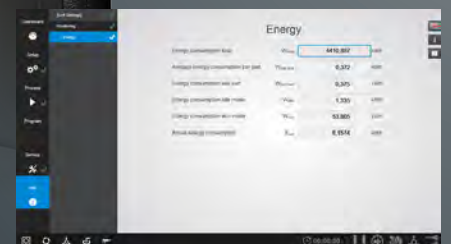

7 Easy-to-read display of current consumer data places the focus on energy efficiency

GEAR DEVELOPMENT BASED ON NOMINAL DATA

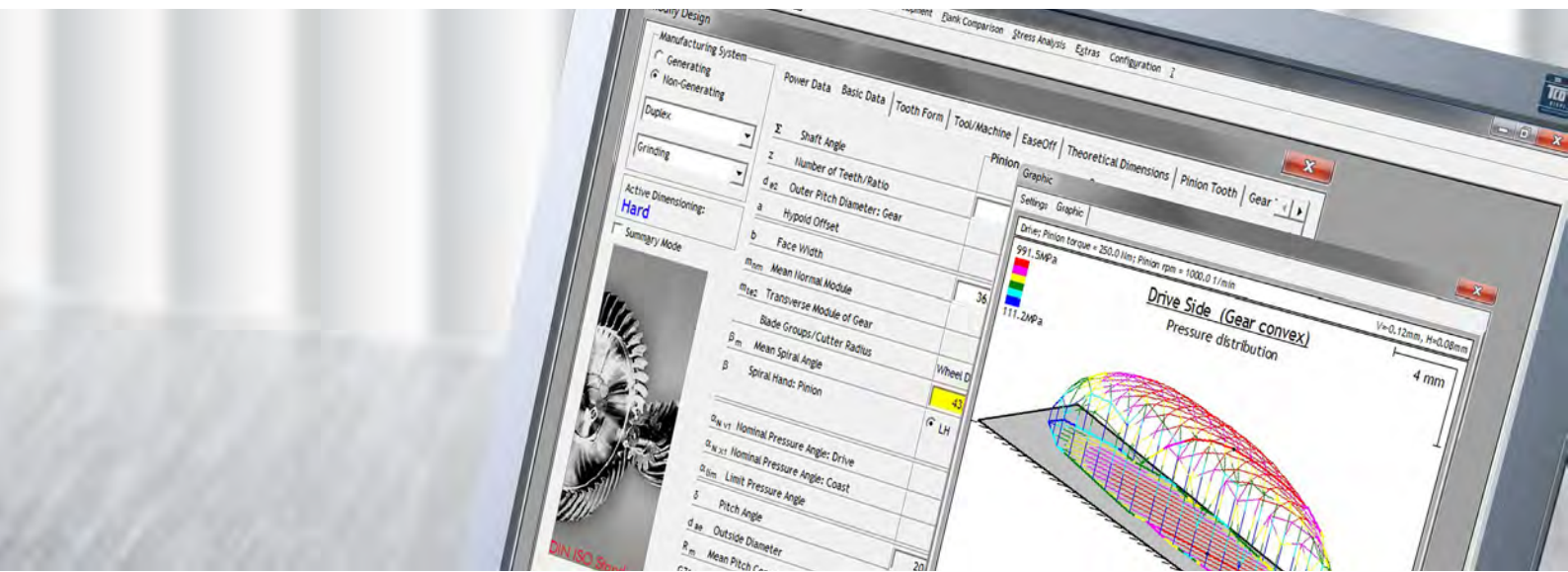

Design and Optimization of High-Performance Bevel Gear Sets

The **KIMoS** (Klingelnberg Integrated Manufacturing of Spiral Bevel Gears) software package supports every step in bevel gear design and optimization. **KOMET** measures corrections for machine settings and any tool data to minimize measured variations on the ground flanks.

As part of this process, all necessary data for the gear cutting process, tool preparation and quality control of the bevel gears to be produced are prepared in parallel. Convenient data handling provides a way to both make use of freely definable development databases in the development phase and to make production-approved data from the production database available to the production and measuring machines used in the process. The software package thus provides the optimal basis for ultra-modern bevel gear production according to the Closed Loop method: **The end result precisely matches what was previously designed and optimized on the computer.**

A modular program package, KIMoS provides the user with the whole range of functionality needed to create application-appropriate gear designs for specific applications. All common gear cutting processes, machines and tool systems are supported.

Among the integral components of KIMoS are a gear-cutting optimization feature with easy-to-operate dialogs, analysis of the expected operation behavior of the gearing, and evaluation of the results with a load-capacity and strength calculation.

For gear design, KIMoS provides:

- Independent design with individual production possibilities taken into account
- Cultivation of expertise within the company as a competitive advantage
- Fast, accurate analysis of testing and production results and gear damage

For gear production, KOMET provides:

- Reliable calculation of correction data immediately following gear measurement
- Machine-specific correction data for bevel gear production
- Maximum process safety by interfacing with the Klingelnberg database

Advanced Bevel Gear Production in a Unique Closed Loop Process

KIMoS – for Optimal Design

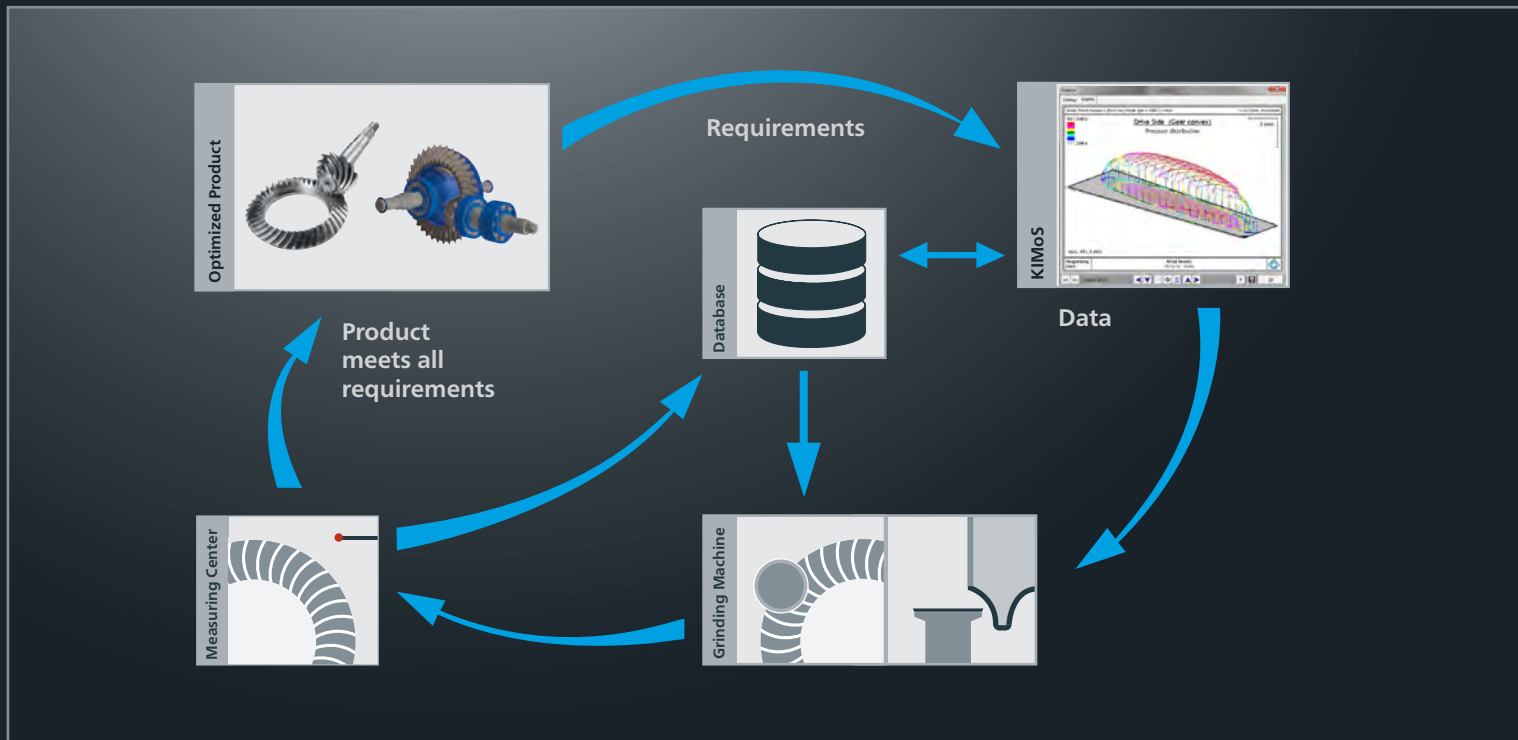

KOMET – from Design to Optimal Production Result

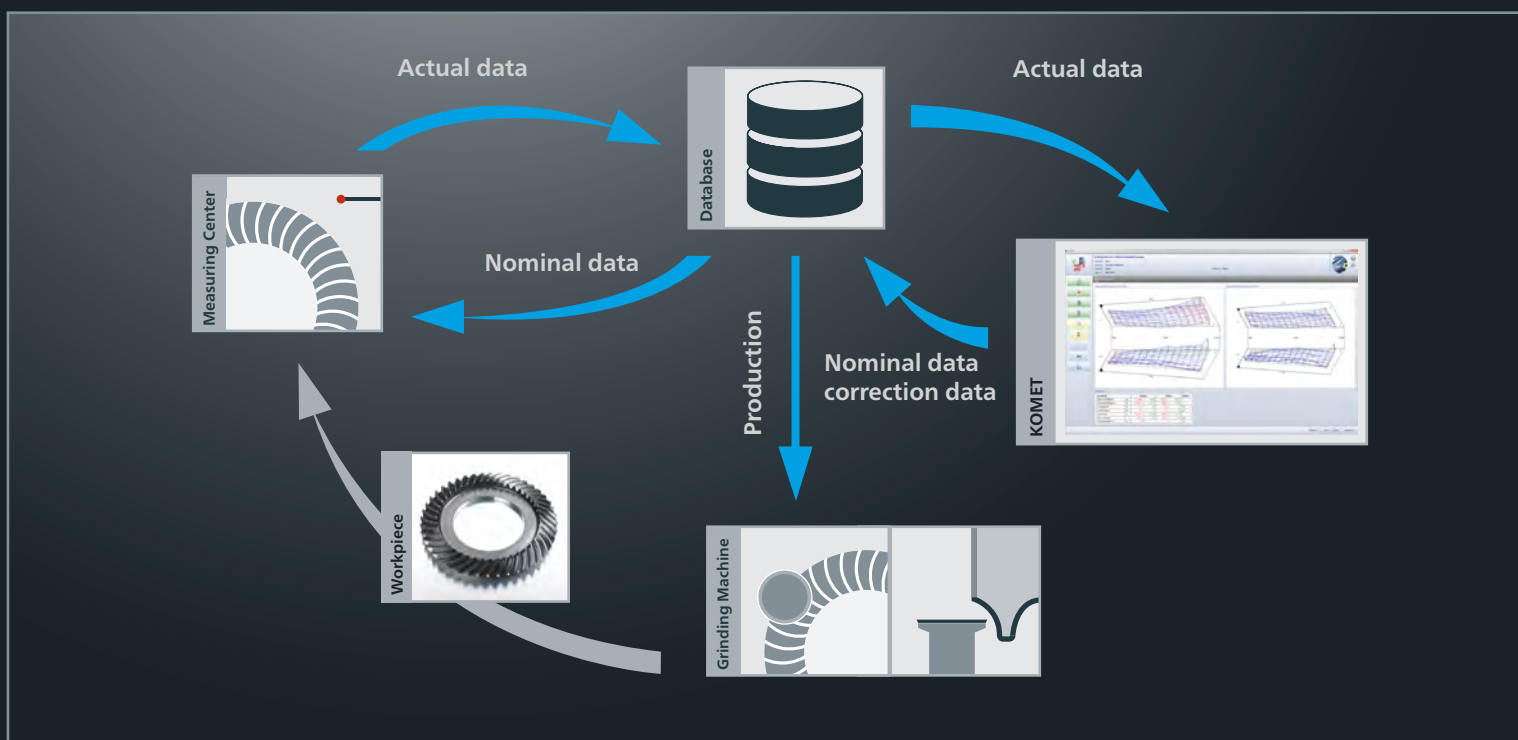

Drive Components with Guaranteed Quality Provide Optimal Performance

In countless industries, Klingelberg solutions have become a fixture in the international market. To meet market requirements for high productivity in mass production and flexibility in small-batch production, Klingelberg offers a range of solution concepts for just about any requirement.

Used throughout the world, the “Simplified with Passion” system plays an important part in ensuring that machine tasks are made simple. Moreover, the Klingelberg system contributes to standardization and quality assurance on a global scale.



Automotive



In cars, spiral bevel gears are used in all-wheel-drive systems and rear-wheel-drive systems to transmit torque "from the transmission to the road". Due to increasing performance requirements, these drives must transmit outputs of over 300 kW in some cases. The bevel gears they use must be efficient, smooth-running, and low-maintenance. Reproducible quality in standard production with the fastest possible production times are key requirements in this industry.

Commercial Vehicles



Commercial vehicles are always rear-wheel-driven. The bevel gear sets they use must transmit power in the range of 500 kW – at extremely high torques. This places high demands on durability and strength. The bevel gears must be efficient, rugged and low-maintenance. Use of the integrated Klingelberg system makes it possible to mass-produce bevel gears with the quality required.

Industrial Gear Units



The industrial gear unit sector comprises many different applications, all of which place great demands on the reliability of the drive components. The bevel gears for these sectors are often produced by companies specializing in small batch sizes and a variety of products. A rigid machine design and flexible, cost-effective tool systems are the keys to success for ranking among the market leaders in these sectors.

Aviation



Bevel gears used in airplanes must embody the highest quality in terms of pitch and runout (DIN 1–3) and must also execute rotational movements with absolute reliability. Just as important are other geometrical features such as surface quality, root geometry, rotational error, high strength and low weight. Frequently used in this industry are special materials, which place extreme demands on tools and processes.

Maritime Propulsion Technology



The bevel gears used in shipbuilding must demonstrate great reliability and durability even under the most extreme external conditions. The high range of component diameters (up to 2 m) requires extensive bevel gear know-how to master the production process. Klingelberg's many years of experience and its certification by all major classification societies are the customer's guarantee of the utmost product quality.

Agriculture



In agricultural applications such as tractors, spiral bevel gears are built into the rear axles. Harvesters and hay machines use straight bevel gears to enable the corresponding functions. Whereas the bevel gear set in a tractor rear axle drive must transmit up to 400 kW, the loads on straight bevel gears are comparably low. The most important market requirement for straight bevel gears is a modern production and a cost efficient solution.

TECHNICAL DATA

G 30

Workpiece data		
Workpiece diameter (max.)	Ø 300 mm	
Normal module range (min. – max.)	0.7 – 8 mm	
Facewidth (max.)	60 mm	
Number of teeth (max.)	360	
Basic angle setting range	±90°	
Tool data		
Grinding wheel diameter (min. – max.)	Ø 32 – 114 mm (1,25 – 4,5")	Ø 127 – 267 mm (5 – 10,5")
Grinding wheel height incl. base plate (max.)	110 mm	135 mm
Tool spindle		
Spindle seat	HSK-E50 DIN 69893-5	
Grinding spindle rotation speed (max.)	8,000 (12,000)* rpm	
Eccentric speed (max.)	3,800 rpm	
Dresser speed (max.)	10,000 rpm	
Nominal grinding wheel drive rating	14 (22)** kW	
Workpiece spindle		
Seating diameter: Oerlikon outer cone 1:4	Ø 140.11 mm	
Seating diameter: inner cone	Ø 99.258 mm (3.9")	
Work spindle bore	Ø 93 mm	
Work spindle depth	280 mm	
Workpiece spindle rotation speed (max.)	1,500 rpm	
General machine data		
Total connected load without filter system	45 kVA	
Machine dimensions including filter system approx. (L x W x H) ***	5,630 x 4,800 x 3,160 mm	
Machine net weight without filter system approx.	16,300 kg	

The above-mentioned maximum values were determined for industry-typical gear units. Further testing may be required to determine whether maximum values can be combined.

*/** Option (options cannot be combined)

*** The dimensions of the standard version are for orientation only. Swivel ranges for doors, operating panels etc. are not taken into account here. The final space requirement depends on the individual configuration of the machine.

Installation Dimensions

G 30: Top view, incl. filter system

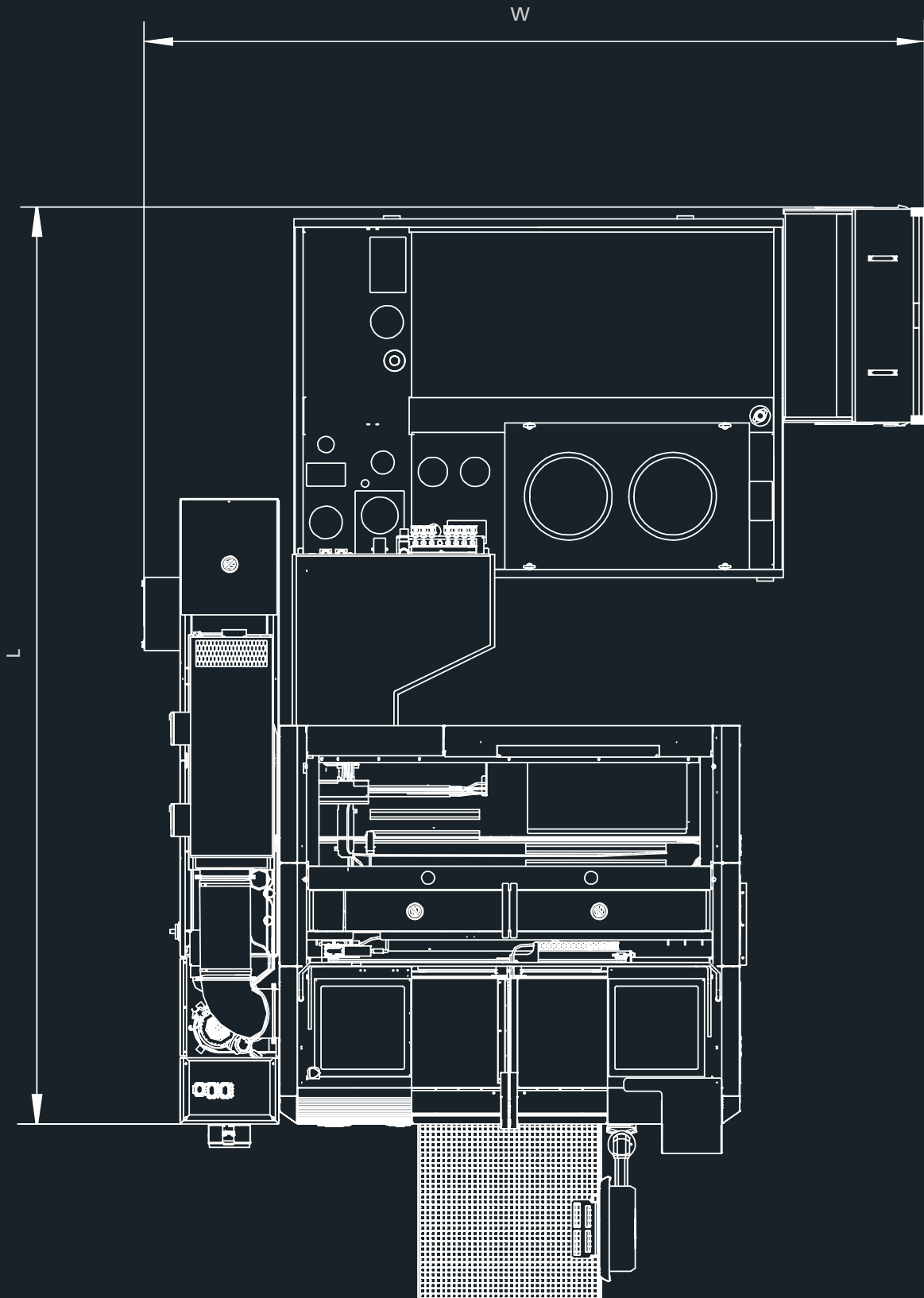

All dimensions in mm

KLINGELNBERG Service

The KLINGELNBERG Group is a world leader in the development and manufacture of machines for bevel gear and cylindrical gear production, and precision measuring centers for gearing and axially symmetrical components, as well as the production of customized high-precision drive components. In addition to the headquarters in Zurich, Switzerland, further development and production facilities are located in Hückeswagen and Ettlingen, Germany.

The company also maintains a presence with Sales and Service offices and numerous marketing agents. On this basis, Klingelberg offers users a comprehensive range of services for all aspects of toothed gear design, manufacturing, and quality inspection. The spectrum includes technical consulting, on-site machine acceptance, operator and software training as well as maintenance contracts.

KLINGELNBERG Solutions

Klingelberg solutions are used in the automotive, commercial vehicle, and aviation industries, as well as in shipbuilding, the wind power industry, and the general transmission manufacturing industry. With numerous R&D engineers around the globe and over 200 registered patents, the company consistently demonstrates its capacity for innovation.

EN 12/2020 - Subject to technical modifications without notice.

FOLLOW US AND STAY UP TO DATE:



KLINGELNBERG AG

Binzmühlestrasse 171
8050 Zürich, Switzerland
Fon: +41 44 278 7979
Fax: +41 44 273 1594

KLINGELNBERG GmbH

Peterstraße 45
42499 Hückeswagen, Germany
Fon: +49 2192 81-0
Fax: +49 2192 81-200

KLINGELNBERG GmbH

Industriestraße 5-9
76275 Ettlingen, Germany
Fon: +49 7243 599-0
Fax: +49 7243 599-165

You can also find your local contact for sales advice at www.klingelberg.com/kontakt